

13A 900V N-channel Enhancement Mode Power MOSFET

1 Description

These N-channel enhanced vdmofets, is obtained by the self-aligned planar technology which reduce the conduction loss, improve switching performance and enhance the avalanche energy. Which accords with the RoHS standard.

2 Features

- Fast switching
- ESD improved capability
- Low on resistance($R_{dson} \leq 0.75\Omega$)
- 100% single pulse avalanche energy test
- 100% ΔV_{DS} test

3 Applications

- Used in various power switching circuit for system miniaturization and higher efficiency.
- Power switch circuit of electron ballast and adaptor.

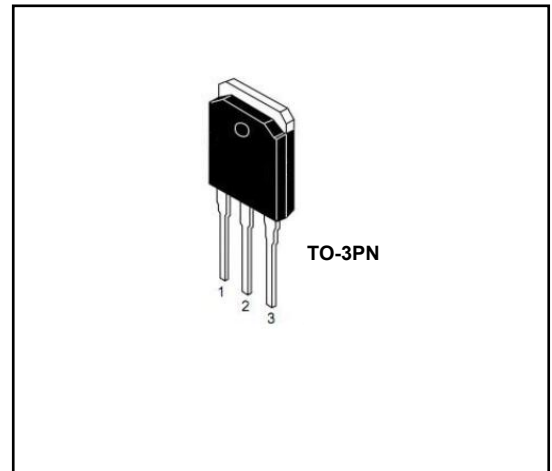
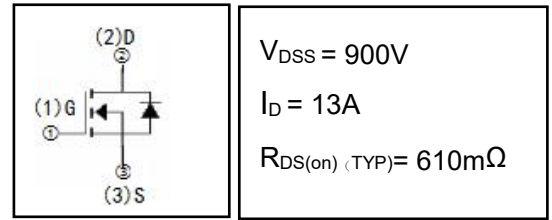

4 Electrical Characteristics

4.1 Absolute Maximum Ratings ($T_c=25^\circ C$, unless otherwise noted)

PARAMETER	SYMBOL	VALUE	UNIT	
Drain-Source Voltage	V_{DS}	900	V	
Gate-Source Voltage	V_{GS}	± 30	V	
Drain Current(continuous) ^(Note 3)	I_D	13	A	
Drain Current(continuous)($T=100^\circ C$) ^(Note 3)	I_D	6.5	A	
Drain Current(Pulsed)	I_{DM}	52	A	
Single Pulse Avalanche Energy ^(Note 4)	E_{AS}	2233	mJ	
Maximum Power Dissipation	$T_a=25^\circ C$	P_{tot}	2.4	W
	$T_c=25^\circ C$	P_{tot}	190	W
Operating Junction Temperature Range	T_j	-55~150	$^\circ C$	
Storage Temperature Range	T_{stg}	-55~150	$^\circ C$	
High Temperature(tin solder)	T_L	300	$^\circ C$	

4.2 Thermal Characteristics

PARAMETER	SYMBOL	VALUE	UNIT
Thermal Resistance, Junction to Case-sink	R_{thJC}	0.45	$^\circ C/W$
Thermal Resistance, Junction to Ambient	R_{thJA}	40	$^\circ C/W$

4.3 Electrical Characteristics (Tc=25°C, unless otherwise noted)

PARAMETER	SYMBOL	Test Condition	VALUE			UNIT
			MIN	TYP	MAX	
Off Characteristics						
Drain-source Breakdown Voltage	BV _{DSS}	I _D =250μA, V _{GS} =0V	900	970	--	V
Zero Gate Voltage Drain Current	I _{DSS}	V _{DS} =900V, V _{GS} =0V, T _C =25°C	--	--	1.0	μA
		V _{DS} =720V, V _{GS} =0V, T _C =125°C	--	--	250	μA
Gate-to-Body Leakage Current	I _{GSS}	V _{GS} =±30V, V _{DS} =0V	--	--	±100	nA
On Characteristics (Note 3)						
Gate threshold voltage	V _{GS(th)}	V _{DS} =V _{GS} , I _D =250μA	2.0	--	4.0	V
Drain-source on Resistance	R _{DS(on)}	V _{GS} =10V, I _D =6.5A	--	0.61	0.75	Ω
Dynamic Characteristics						
Input Capacitance	C _{iss}	V _{GS} =0V, V _{DS} =25V, f=1.0MHz	--	4100	--	pF
Output Capacitance	C _{oss}		--	310	--	
Reverse Transfer Capacitance	C _{rss}		--	88	--	
Turn-on Delay Time	T _{d(on)}	I _D =13A, V _{DD} =400V, V _{GS} =10V, R _G =25Ω L=200uH	--	65	--	ns
Turn-on Rise Time	t _r		--	35	--	
Turn-off Delay Time	T _{d(off)}		--	224	--	
Turn-off Fall	t _f		--	38	--	
Total Gate Charge	Q _g	I _D =13A, V _{DD} =450V, V _{GS} =10V	--	68	--	nC
Gate-to-Source Charge	Q _{gs}		--	15	--	
Gate-to-Drain("Miller")C harge	Q _{gd}		--	32	--	
Drain-Source Diode Characteristics						
Diode Forward Voltage (Note 3)	V _{FSD}	V _{GS} =0V, I _S =13A	--	--	1.5	V
Continuous Source Current (BodyDiode) (Note 3)	I _S		--	--	13	A
Reverse Recovery Time	trr	T _J =25°C, I _F =13A, dI _F /dt=100A/μS, V _{GS} =0V	--	1.2	--	us
Reverse Recovery Charge	Q _{rr}		--	21	--	uc

Notes:

- 1: Repetitive rating, pulse width limited by maximum junction temperature.
- 2: Surface mounted on FR4 Board, t_s≤10sec.
- 3: Pulse width ≤ 300μs, duty cycle ≤ 2%.
- 4: L=30 mH, I_D=12.2A, V_{DD}=150V, Start T_J=25°C.

5 Typical Test Circuit and Waveform

<p style="text-align: center;">Gate Charge Test Circuit</p>	<p style="text-align: center;">Gate Charge Waveforms</p>
<p style="text-align: center;">Resistive Switching Test Circuit</p>	<p style="text-align: center;">Resistive Switching Waveforms</p>
<p style="text-align: center;">Diode Reverse Recovery Test Circuit</p>	<p style="text-align: center;">Diode Reverse Recovery Waveform</p>

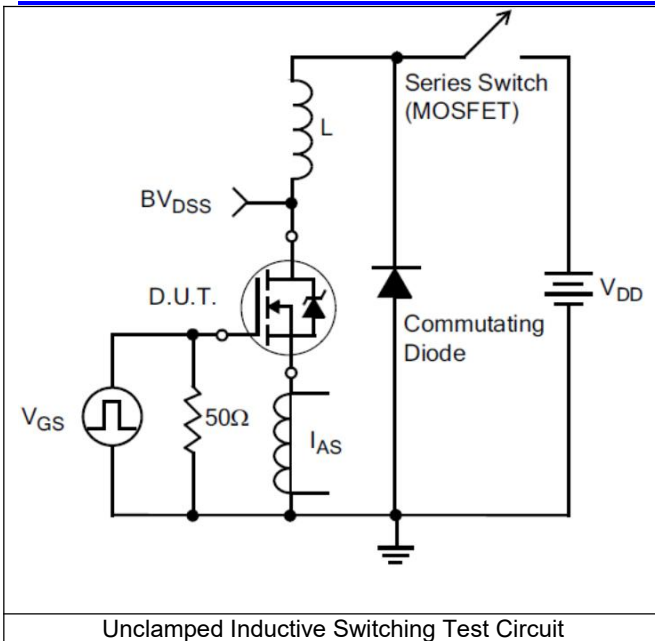

Unclamped Inductive Switching Test Circuit

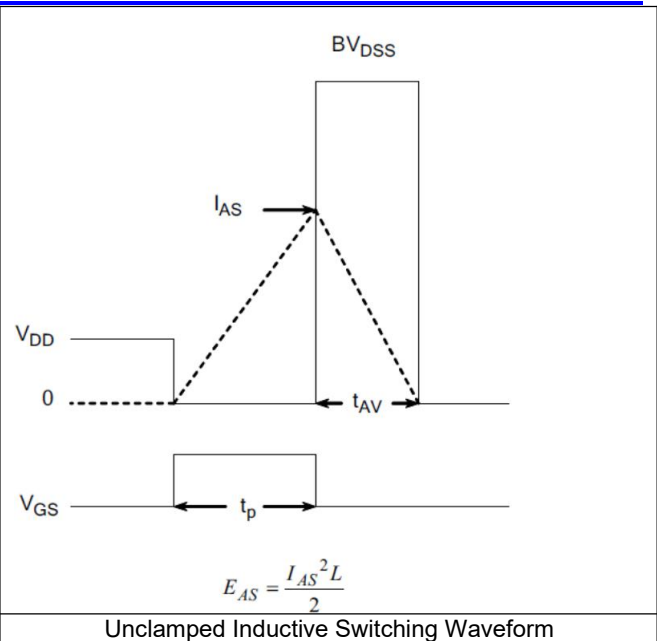

Unclamped Inductive Switching Waveform

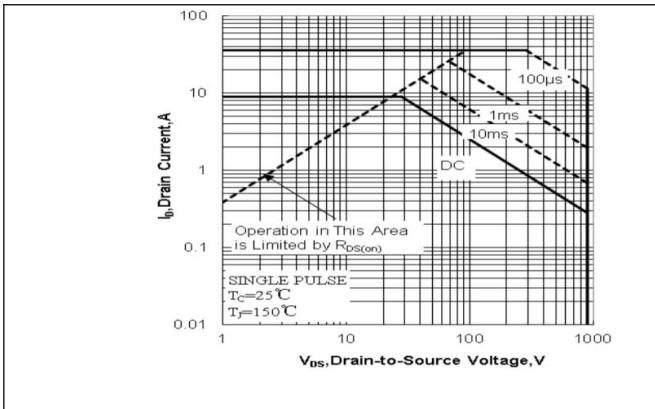

Maximum Forward Bias Safe Operating Area

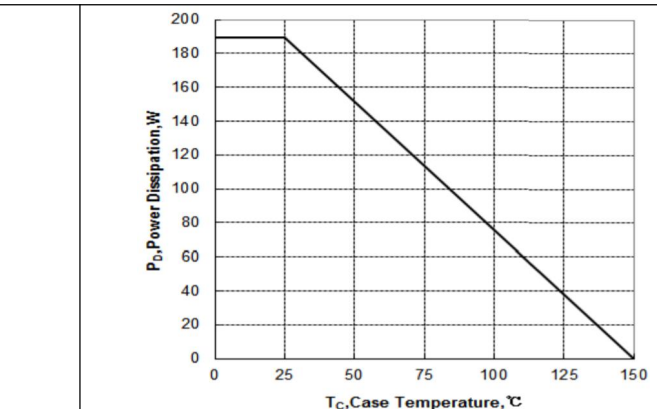

Maximum Power dissipation vs Case Temperature

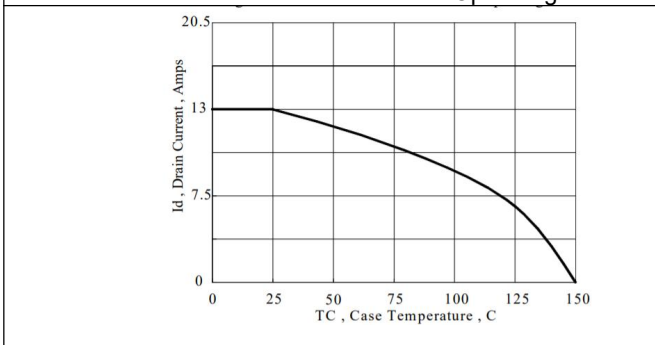

Maximum Continuous Drain Current vs Case Temperature

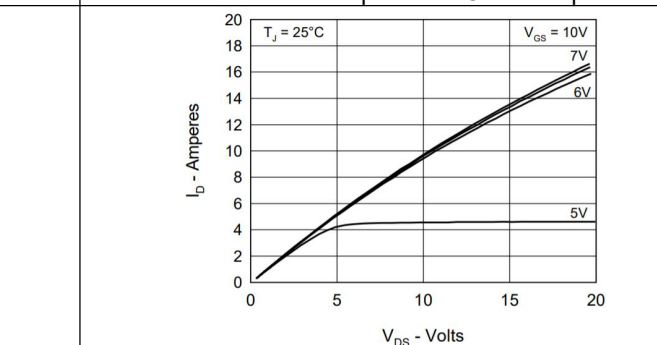

Typical Output Characteristics

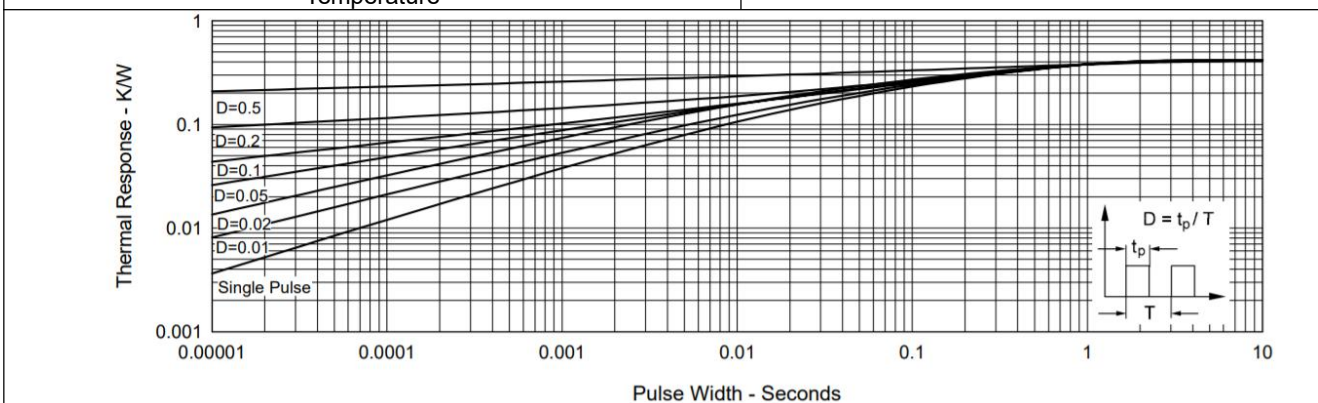

Maximum Effective Thermal Impedance , Junction to Case

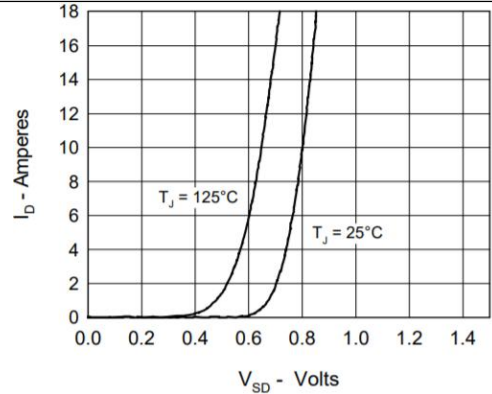
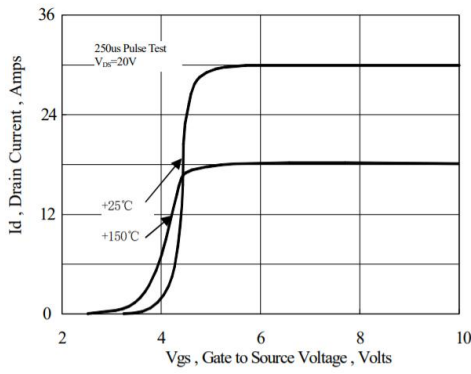

Typical Transfer Characteristics

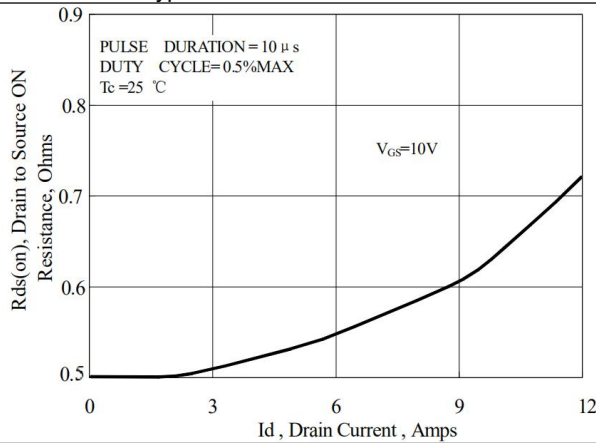

Typical Body Diode Transfer Characteristics

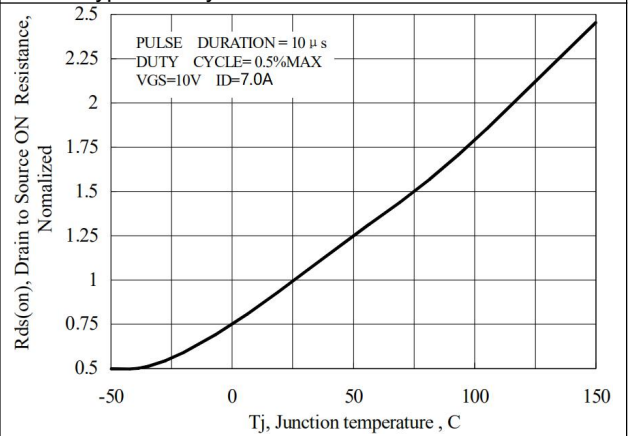

Typical Drain to Source ON Resistance vs Drain Current

Typical Drain to Source on Resistance vs Junction Temperature

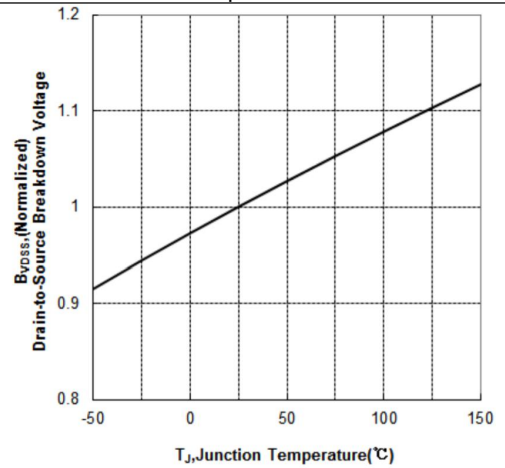
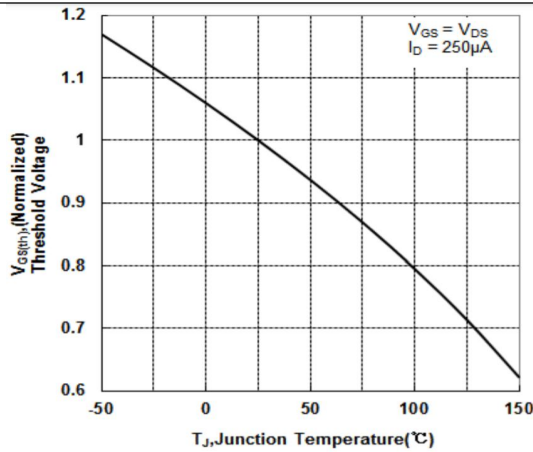

Typical Theshold Voltage vs Junction Temperature

Typical Breakdown Voltage vs Junction Temperature

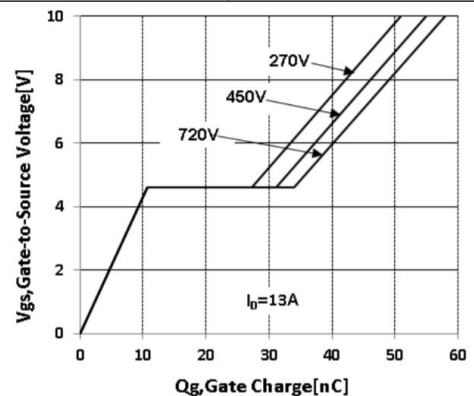
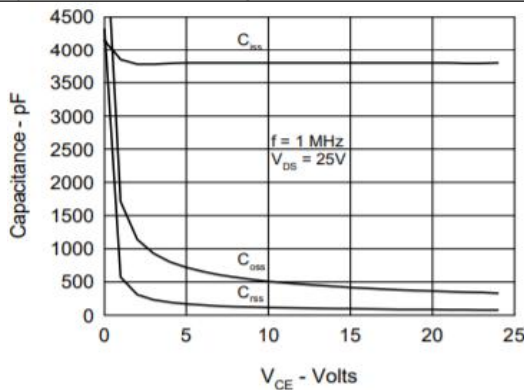

Typical Capacitance vs Drain to Source Voltage

Typical Gate Charge vs Gate to Source Voltage

6 Product Specifications and Packaging Models

Product Model	Package Type	Mark Name	RoHS	Package	Quantity
13N90	TO-3PN	13N90	Pb-free	Tube	300/box
13N90	TO-3P	13N90	Pb-free	Tube	300/box

7 Dimensions

TO-3PN PACKAGE OUTLINE DIMENSIONS

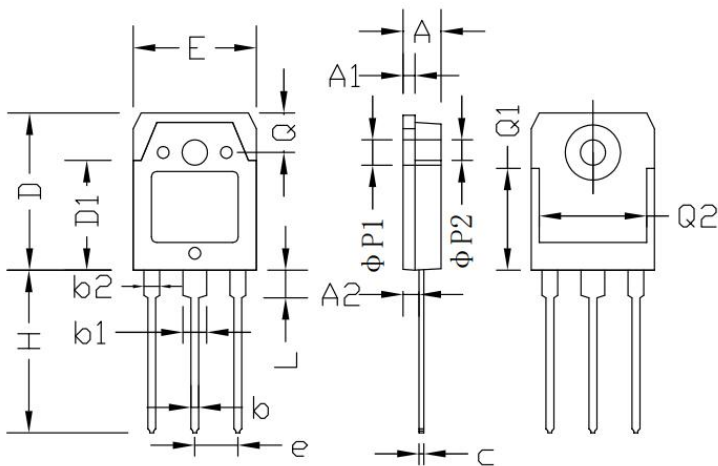

Symbol	Dimensions In Millimeters		Dimensions In Inches	
	min.	max.	min.	max.
A	4.60	5.00	0.181	0.197
A1	1.45	1.65	0.057	0.065
A2	2.20	2.60	0.087	0.102
b	0.80	1.20	0.032	0.047
b1	2.80	3.20	0.110	0.126
b2	1.80	2.20	0.071	0.087
C	0.55	0.75	0.022	0.030
D	19.20	19.80	0.756	0.780
D1	13.10	14.70	0.516	0.578
E	15.40	15.80	0.607	0.623
e	5.45 TYP		0.215 TYP	
H	19.80	20.50	0.780	0.807
L	3.20	3.70	0.126	0.146
ΦP1	3.20 TYP		0.126 TYP	
ΦP2	3.50 TYP		0.138 TYP	
Q	5.00 TYP		0.197 TYP	
Q1	12.40 TYP		0.488 TYP	
Q2	12.6	-	0.496	-

8 Attentions

- Jiangsu Donghai Semiconductor Technology Co., Ltd. reserves the right to change the specification without prior notice! The customer should obtain the latest version of the information before making the order and verify that the information is complete and up to date.
- It is the responsibility of the purchaser for any failure or failure of any semiconductor product under certain conditions. It is the responsibility of the purchaser to comply with safety standards and to take safety measures in the system design and machine manufacturing of WXDH products in order to avoid potential risk of failure. Injury or property damage.
- Product promotion is endless, our company will be dedicated to provide customers with better products.

9 Appendix

Revision history:

Date	REV.	Description	Page
2020.11.12	1.0	Original	