

80A 600V Fast recovery diode

1 Description

80A, 600V Ultrafast Diodes They have a low forward voltage drop and are of planar, silicon nitride passivated, ion-implanted, epitaxial construction. These devices are intended for use as energy steering/clamping diodes and rectifiers in a variety of switching power supplies and other power switching applications. Their low stored charge and ultrafast recovery with soft recovery characteristics minimizes ringing and electrical noise in many power switching circuits, thus reducing power loss in the switching transistor

2 Features

- Low power loss,
- high efficiency Low forward voltage,
- high current capability High surge capacity
- Super fast recovery times
- high voltage

3 Applications

- Switching Power Supply
- Power Switching Circuits
- General Purpose

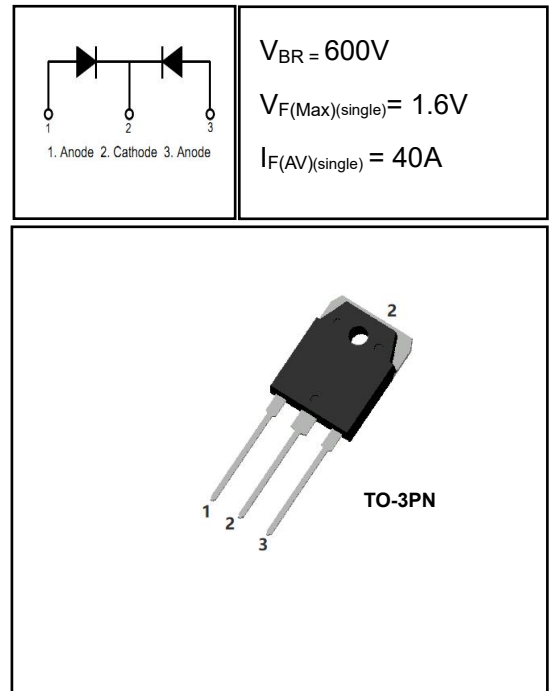
4 Electrical Characteristics

4.1 Absolute Maximum Ratings (Tc=25°C, unless otherwise noted)

PARAMETER		SYMBOL	VALUE	UNIT
Peak Repetitive Reverse Voltage		V_{RRM}	600	V
Working Peak Reverse Voltage		V_{RWM}	600	V
DC Blocking Voltage		V_R	600	V
Average Rectified Forward Current(single)	Tc=135°C	$I_{F(AV)}$	40	A
Average Rectified Forward Current(double)	Tc=135°C		80	A
Repetitive Peak Surge Current(single)		I_{FRM}	60	A
Nonrepetitive Peak Surge Current(single)	t=8.3ms	I_{FSM}	400	A
Avalanche Energy(single)	L=1mH	E_{AS}	110	mJ
Operating Junction Temperature Range		T_j	-55~150	°C
Storage Temperature Range		T_{stg}	-55~150	°C

4.2 Thermal Characteristics

PARAMETER	SYMBOL	VALUE	UNIT
Thermal Resistance, Junction to Case-sink	R_{thJC}	1.05	°C/W



4.3 Electrical Characteristics (Tc=25°C, unless otherwise noted)

PARAMETER	SYMBOL	TEST CONDITION	MIN	TYP	MAX	UNIT
Maximum Instantaneous Forward Voltage	V _F	I _F = 30A	-	1.20	-	V
		I _F = 40A	-	1.30	1.60	V
		I _F = 40A, T _C = 150°C	-	-	1.45	V
		I _F = 50A	-	1.45	1.8	V
Maximum Instantaneous Reverse	I _R	V _R = 600V	-	-	5	μA
		V _R = 600V, T _C = 150°C	-	-	1	mA
Maximum Reverse Recovery Time	t _{rr}	V _R =30V I _F =1A -di/dt=50A/us	-	36	50	ns
Total capacitance	C _{tot}	V _R =0V f=1MHz	-	730	-	pF
DC Blocking Voltage	V _{BR}	I _R =100μA	610	660	-	V

DEFINITIONS

V_F = Instantaneous forward voltage (pw = 300μs, D = 2%).

I_R = Instantaneous reverse current.

RθJC = Thermal resistance junction to case.

pw = pulse width.

D = duty cycle.

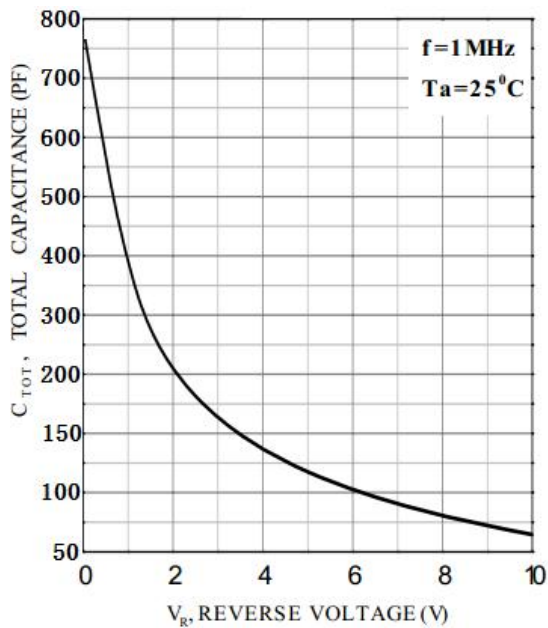
5 Typical characteristics diagrams


FIGURE 1. Total capacitance vs Voltage

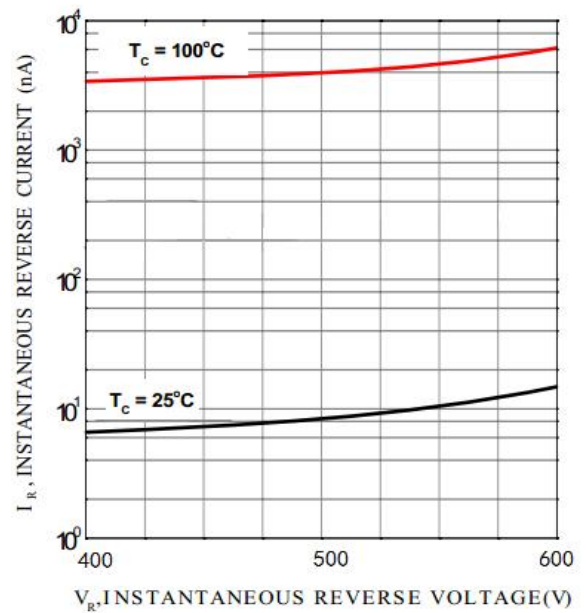


FIGURE 2. REVERSE CURRENT vs REVERSE VOLTAGE

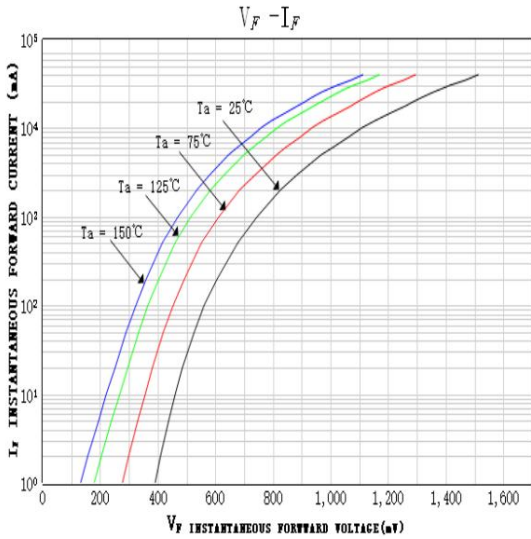


FIGURE 3. FORWARD CURRENT vs FORWARD VOLTAGE

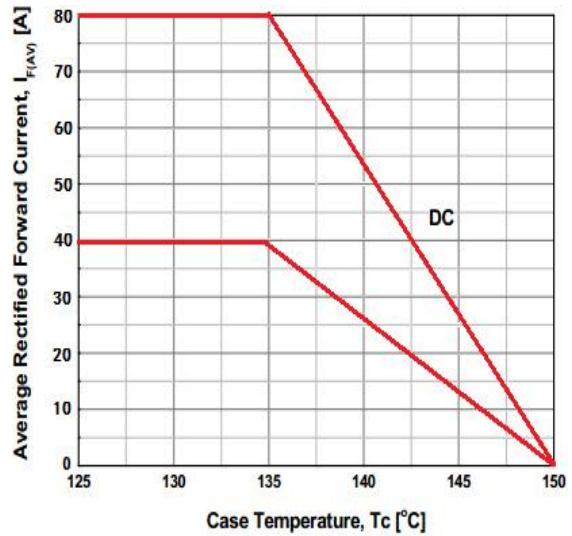


FIGURE 4. CURRENT DERATING CURVE

6 Typical Test Circuit and Waveform

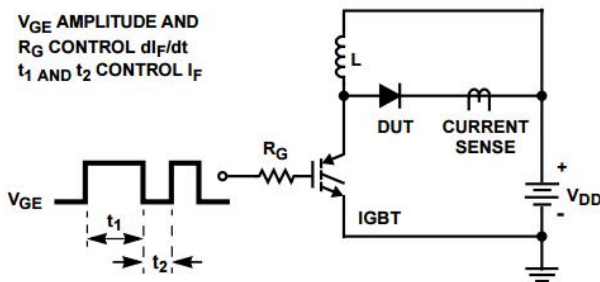


FIGURE 5. trr TEST CIRCUIT

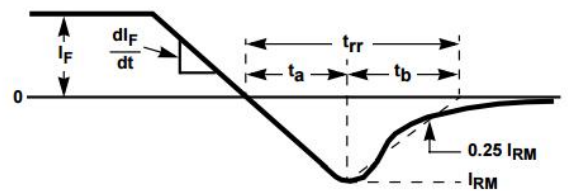


FIGURE 6. trr WAVEFORMS AND DEFINITIONS

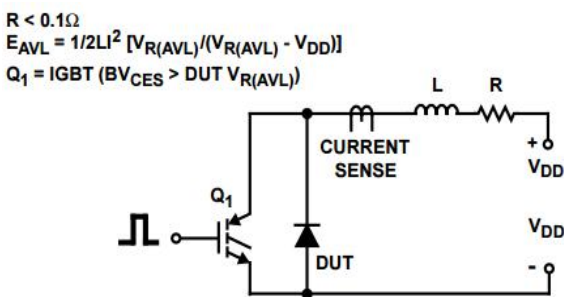


FIGURE 7. AVALANCHE ENERGY TEST CIRCUIT FIGURE

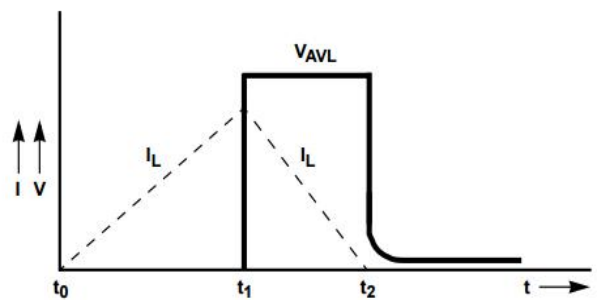


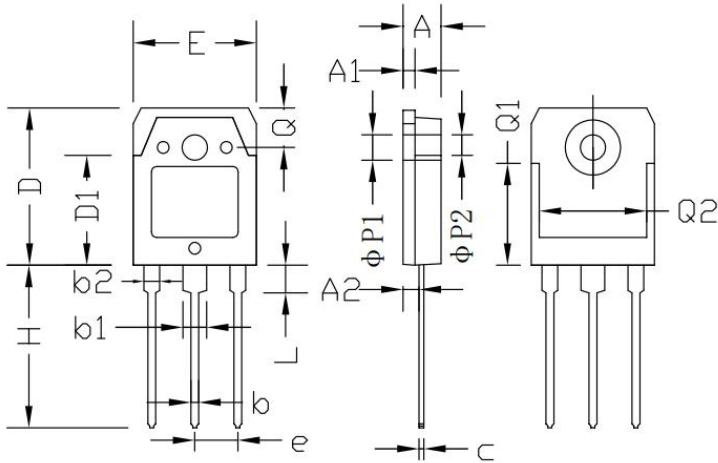
FIGURE 8. AVALANCHE CURRENT AND VOLTAGE WAVEFORMS

7 Product Specifications and Packaging Models

Product Model	Package Type	Mark Name	RoHS	Package	Quantity
MUR8060DCT	TO-3PN	MUR8060DCT	Pb-free	Tube	300/box

8 Dimensions

TO-3PN PACKAGE OUTLINE DIMENSIONS



Symbol	Dimensions In Millimeters		Dimensions In Inches	
	min.	max.	min.	max.
A	4.60	5.00	0.181	0.197
A1	1.45	1.65	0.057	0.065
A2	2.20	2.60	0.087	0.102
b	0.80	1.20	0.032	0.047
b1	2.80	3.20	0.110	0.126
b2	1.80	2.20	0.071	0.087
C	0.55	0.75	0.022	0.030
D	19.20	19.80	0.756	0.780
D1	13.10	14.70	0.516	0.578
E	15.40	15.80	0.607	0.623
e	5.45 TYP		0.215 TYP	
H	19.80	20.50	0.780	0.807
L	3.20	3.70	0.126	0.146
ΦP1	3.20 TYP		0.126 TYP	
ΦP2	3.50 TYP		0.138 TYP	
Q	5.00 TYP		0.197 TYP	
Q1	12.40 TYP		0.488 TYP	
Q2	12.6	-	0.496	-

10 Attentions

- Jiangsu Donghai Semiconductor Co.,Ltd.. reserves the right to change the specification without prior notice! The customer should obtain the latest version of the information before making the order and verify that the information is complete and up to date.
- It is the responsibility of the purchaser for any failure or failure of any semiconductor product under certain conditions. It is the responsibility of the purchaser to comply with safety standards and to take safety measures in the system design and machine manufacturing of Jiangsu Donghai Semiconductor Co.,Ltd. products in order to avoid potential risk of failure. Injury or property damage.
- Product promotion is endless, our company will be dedicated to provide customers with better products.

11 Appendix

Revision history:

Date	REV.	Description	Page
2022.12.20	1.0	Original	