

75A 650V Half bridge module

1 Description

These Insulated Gate Bipolar Transistor used advanced trench and Fieldstop technology design, provided excellent $V_{CE(sat)}$ and switching speed ,low gate charge. Which accords with the RoHS standard.

2 Features

- FS Trench Technology, Positive temperature coefficient
- Low saturation voltage: $V_{CE(sat)}$, typ = 1.7V @ $I_c = 75A$ and $T_j = 25^\circ C$
- Extremely enhanced avalanche capability

3 Applications

- Welding
- UPS
- Three-level Inverter
- AC and DC servo drive amplifier



Type	V_{CE}	I_c	$V_{CE(sat)}, T_j=25^\circ C$	T_{jop}	Package
DGA75H65M2T	650V	75A ($T_j=100^\circ C$)	1.7V (Typ)	175°C	34MM

4 Equivalent Circuit Schematic

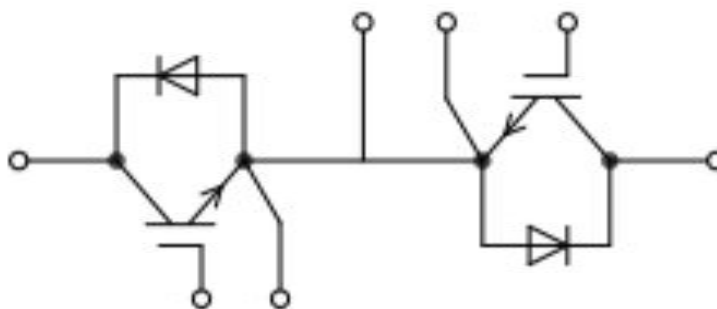

5 Electrical Characteristics

5.1 Absolute Maximum Ratings (IGBT) (Tc=25°C, unless otherwise specified)

Parameter	Symbol	Value	Units
Collector-to-Emitter Voltage	V_{CE}	650	V
Gate-to-Emitter Voltage	V_{GE}	±30	V
DC Collector current	I_C	$T_j=25^\circ\text{C}$	150
		$T_j=100^\circ\text{C}$	75
Pulsed Collector Current #1	I_{CM}	300	A
Maximum Power Dissipation @Tc=25°C	P_D	500	W

Notes: #1 Pulse duration is limited by $T_{j,max}$

5.2 Absolute Maximum Ratings (Diode) (Tc=25°C, unless otherwise specified)

PARAMETER	SYMBOL	VALUE	UNIT
Peak Repetitive Reverse Voltage	V_{RRM}	650	V
DC Blocking Voltage	V_R	650	V
Average Rectified Forward Current	$I_{F(AV)}$	75	A
Repetitive Peak Surge Current	I_{FRM}	150	A
Nonrepetitive Peak Surge Current(single)	$t_p=8.3\text{ms}$ I_{FSM}	600	A

5.3 IGBT Module

Parameter	Symbol	VALUE	Units
Junction Temperature Range	T_{jmax}	-45~175	°C
Operating Junction Temperature	T_{jop}	-45~150	°C
Storage Temperature Range	T_{stg}	-45~150	°C
Isolation Voltage $R_{MS}, f=50\text{Hz}, t=1\text{min}$	V_{ISO}	4000	V

5.4 Thermal Characteristics (IGBT Module)

Parameter	Symbol	Rating	Units
Thermal Resistance Junction to Case	IGBT	0.30	°C/W
	Diode	0.48	

5.5 Electrical Characteristics (IGBT) (Tc=25°C, unless otherwise specified)

Parameter	Symbol	Conditions	Value			Units
			Min	Typ	Max	
Static Characteristics						
Collector-to-Emitter Breakdown Voltage	$V_{(BR)CES}$	$I_C=1mA, V_{GE}=0V, T_j=25^\circ C$	650	--	--	V
Collector-to-Emitter Leakage Current	I_{CES}	$V_{CE}=650V, V_{GE}=0V, T_j=25^\circ C$	--	--	20	μA
		$V_{CE}=650V, V_{GE}=0V, T_j=150^\circ C$	--	--	5.0	mA
Gate-to-Emitter Leakage Current	I_{GES}	$V_{GE}=\pm 30V, V_{CE}=0V, T_j=25^\circ C$	--	--	± 100	nA
		$V_{GE}=\pm 30V, V_{CE}=0V, T_j=150^\circ C$	--	--	± 200	nA
Gate Threshold Voltage	$V_{GE(th)}$	$V_{CE}=V_{GE}, I_C=1mA$	5.0	6.0	7.5	V
Collector-emitter saturation voltage	V_{CEsat}	$V_{GE}=15V, I_C=75A, T_j=25^\circ C$	--	1.7	2.0	V
		$V_{GE}=15V, I_C=75A, T_j=150^\circ C$	--	1.95	-	V
Dynamic Characteristics						
Input Capacitance	C_{iss}	$V_{CE}=25V, V_{GE}=0V, f=1MHz, T_a=25^\circ C$	--	5474	--	pF
Output Capacitance	C_{oss}		--	243	--	
Reverse Transfer Capacitance	C_{rss}		--	35	--	
IGBT Characteristics						
Turn-on delay time	$t_{d(on)}$	$V_{CE}=400V, I_C=75A, R_g=5\Omega, V_{GE}=15V, \text{感性负载}, T_j=25^\circ C$	--	41	--	nS
Rise time	t_r		--	125	--	nS
Turn-off delay time	$t_{d(off)}$		--	143	--	nS
Fall time	t_f		--	95	--	nS
Turn-on energy	E_{on}		--	2.65	--	mJ
Turn-off energy	E_{off}		--	1.91	--	mJ
Total switching energy	E_{ts}		--	4.56	--	mJ
Turn-on delay time	$t_{d(on)}$	$V_{CE}=400V, I_C=75A, R_g=10\Omega, V_{GE}=15V, \text{感性负载}, T_j=175^\circ C$	--	37	--	nS
Rise time	t_r		--	119	--	nS
Turn-off delay time	$t_{d(off)}$		--	169	--	nS
Fall time	t_f		--	147	--	nS
Turn-on energy	E_{on}		--	2.69	--	mJ
Turn-off energy	E_{off}		--	2.33	--	mJ
Total switching energy	E_{ts}		--	5.02	--	mJ
Gate charge	Q_g	$V_{CE}=520V, I_C=75A, V_{GE}=15V$	--	187	--	nC

5.6 Electrical Characteristics (Diode) (Tc=25°C, unless otherwise specified)

Parameter	Symbol	Conditions	Value			Units
			Min	Typ	Max	
Diode forward voltage	V_F	$I_F=75A, T_j=25^\circ C$	--	1.72	2.5	V
		$I_F=75A, T_j=150^\circ C$	--	1.10	--	V
Diode reverse recovery time	t_{rr}	$I_F=0.5A, I_R=1.0A, I_{rr}=0.25A$	--	40	--	ns
Diode reverse recovery time	t_{rr}	$I_F=75A,$	--	105	--	ns
Diode peak reverse recovery current	I_{rrm}	$di/dt=200A/\mu s,$	--	2.2	--	A
Diode reverse recovery charge	Q_{rr}		--	126	--	nC
Maximum Instantaneous Reverse	I_R	$V_R=650V$	--	--	10	μA
		$V_R=650V, T_C=150^\circ C$	--	--	5	mA

5 Typical Characteristic Curves

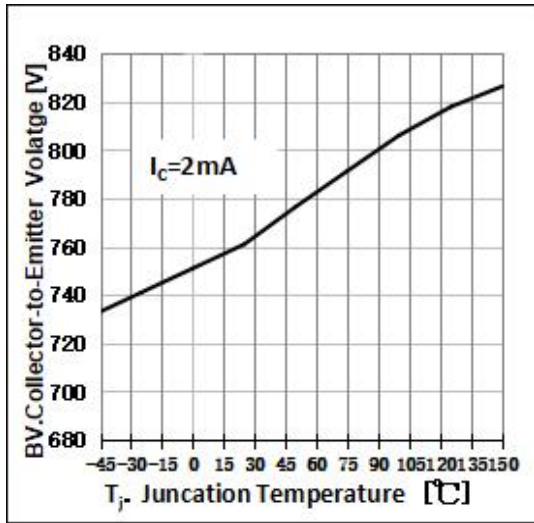

Fig1. Collector-to-Emitter Breakdown Voltage Temperature characteristic

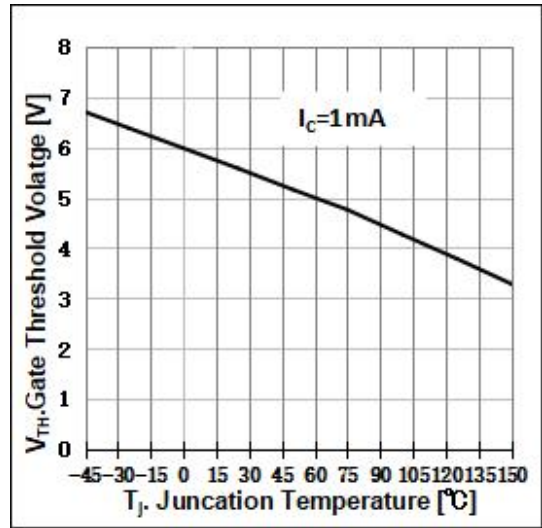

Fig2. Gate Threshold Voltage Temperature characteristic

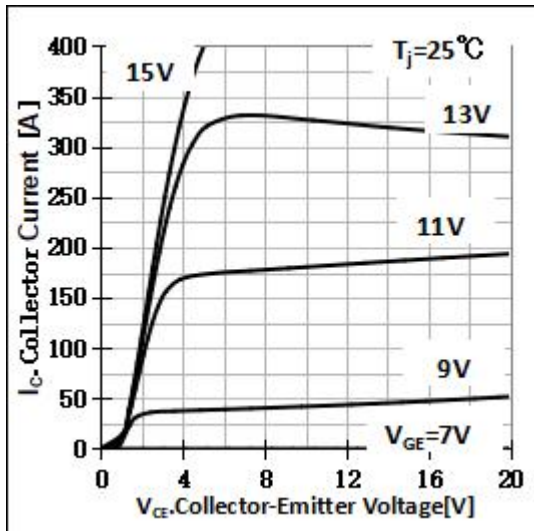

Fig3. Typical output characteristic

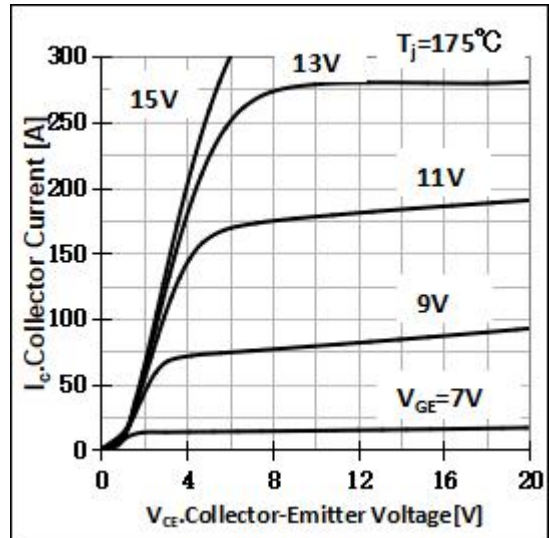

Fig4. Typical output characteristic

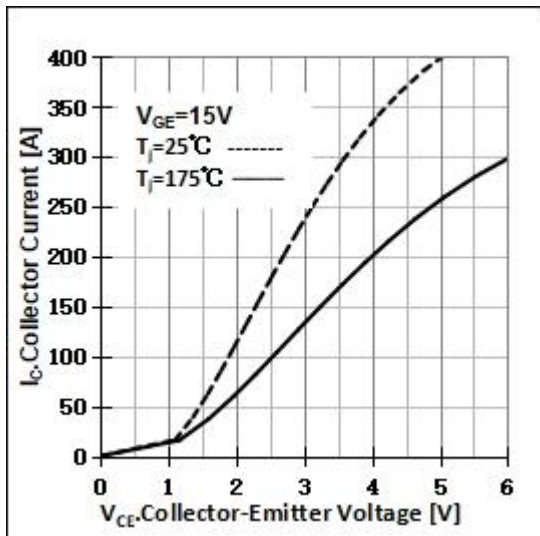

Fig5. Collector-emitter saturation voltage Characteristic

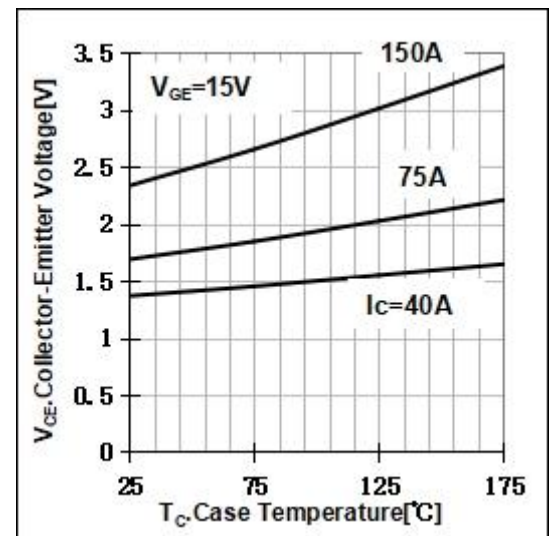

Fig6. Collector-emitter saturation voltage Temperature Characteristic

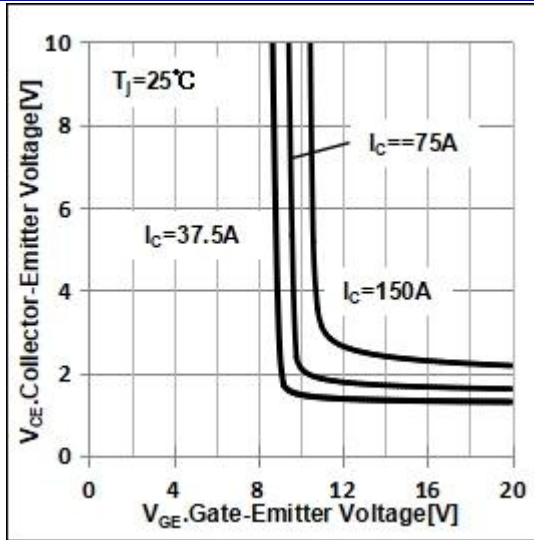

Fig7. Typical Transfer characteristic curve of Saturation Voltage vs Vge

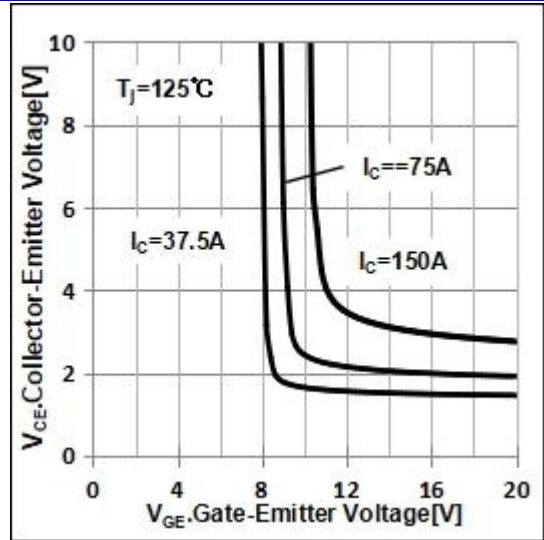

Fig8. Typical Transfer characteristic curve of Saturation Voltage vs Vge

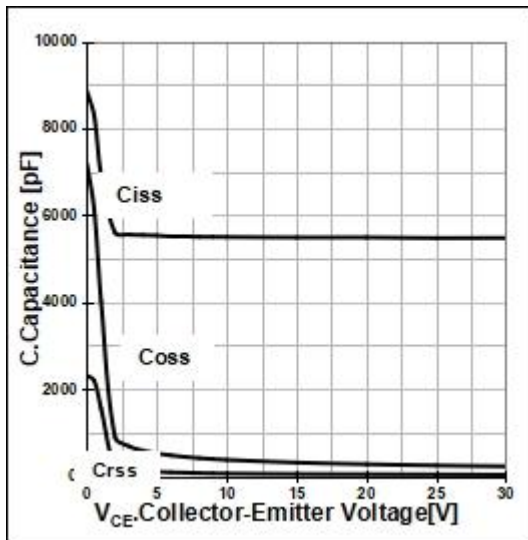

Fig9. Typical capacitance as a function of collector-emitter voltage

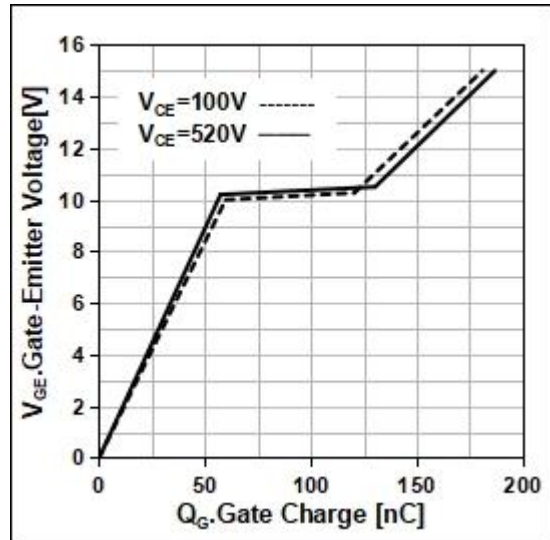

Fig10. Typical gate charge

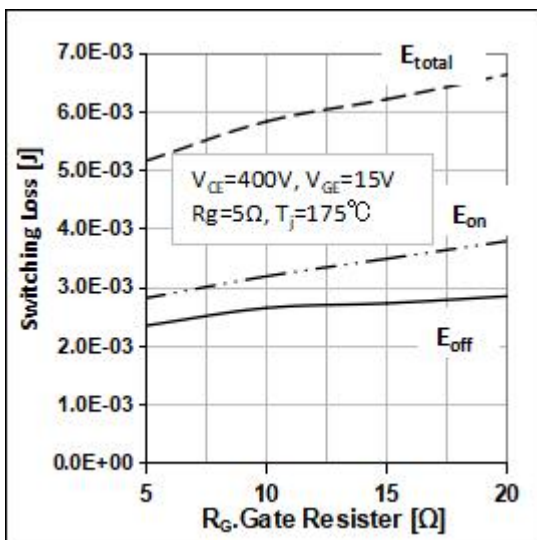

Fig11. Typical switching energy losses as a function of gate resistor

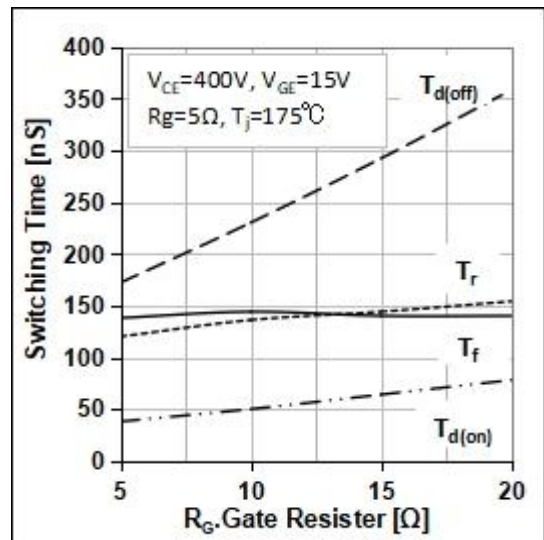

Fig12. Typical switching times as a function of gate resistor

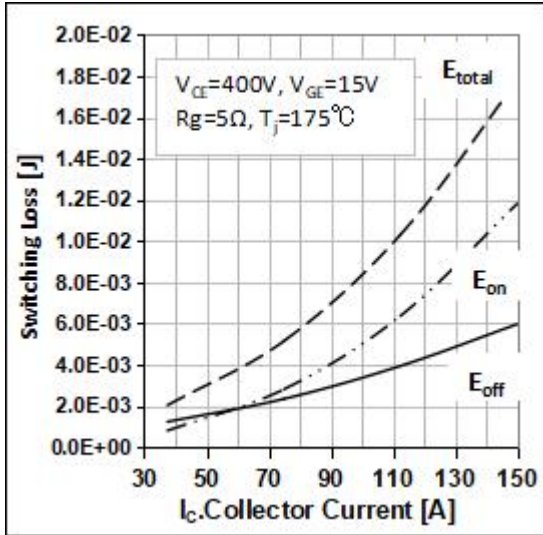

Fig13. Typical switching energy losses as a function of Collector Current

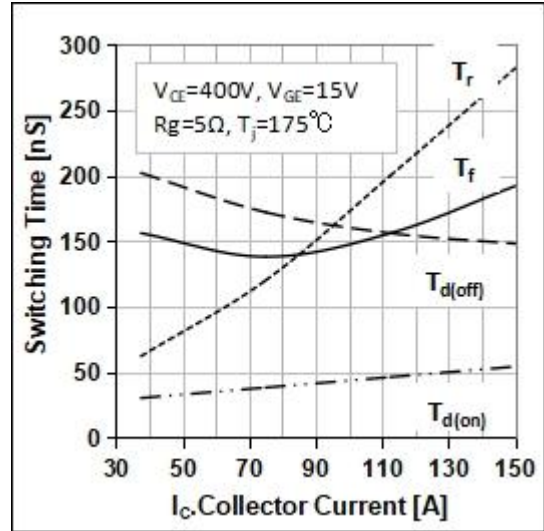

Fig14. Typical switching times as a function of Collector Current

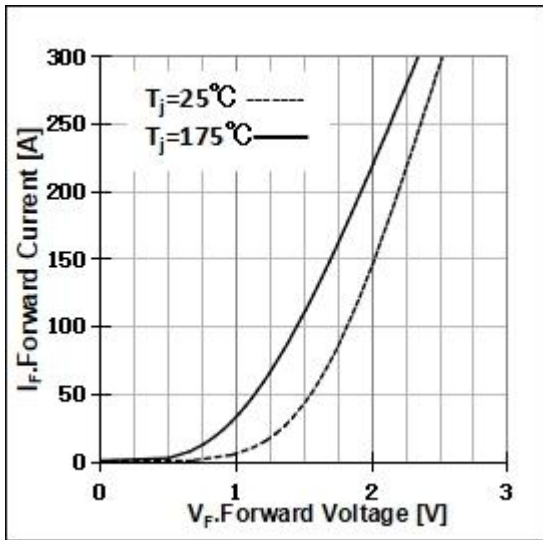

Fig15. Typical diode forward current as a function of forward voltage

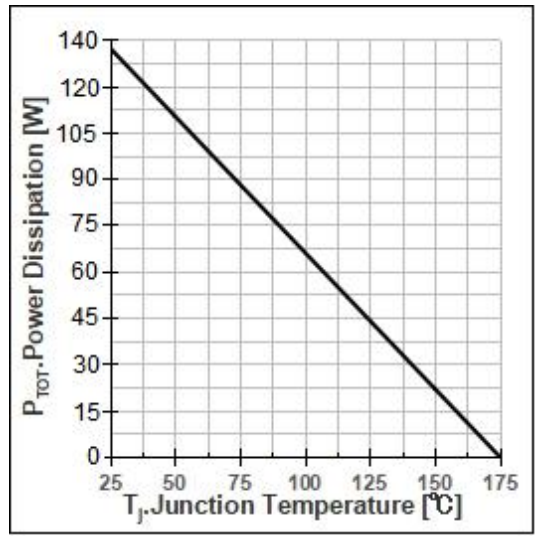
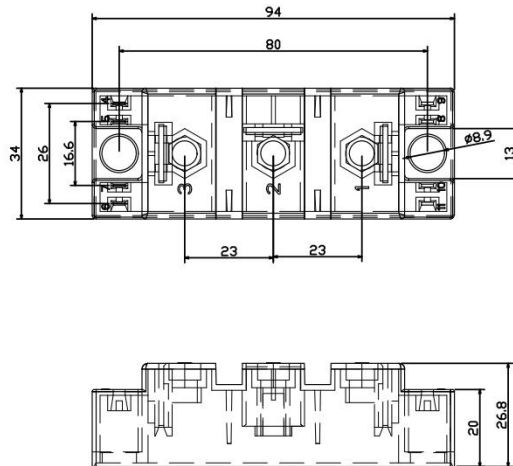
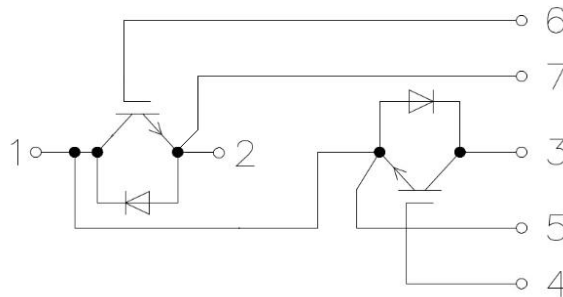

Fig16. Power dissipation temperature characteristic

7 Dimensions



7.1 Circuit Schematic



8 Attentions

- Jiangsu Donghai Semiconductor Technology CO.,LTD. reserves the right to change the specification without prior notice! The customer should obtain the latest version of the information before making the order and verify that the information is complete and up to date.
- It is the responsibility of the purchaser for any failure or failure of any semiconductor product under certain conditions. It is the responsibility of the purchaser to comply with safety standards and to take safety measures in the system design and machine manufacturing of Donghai products in order to avoid potential risk of failure. Injury or property damage.
- Product promotion is endless, our company will be dedicated to provide customers with better products.

9 Appendix

Revision history:

Date	REV.	Description	Page
2020.10.12	1.0	Original	