

## 20A 650V SiC Schottky Barrier Diode

### 1 Description

SiC Series products family offers state of the art performance. It is designed for high frequency applications where high efficiency and high reliability are required.

### 2 Features

- high voltage
- Zero Reverse Recovery Current
- Zero Forward Recovery Voltage
- Positive Temperature Coefficient on VF
- 175°C Operating Junction Temperature

### 3 Applications

- Switching Mode Power Supplies
- Power Factor Correction
- Motor drive, PV Inverter, Wind Power Station

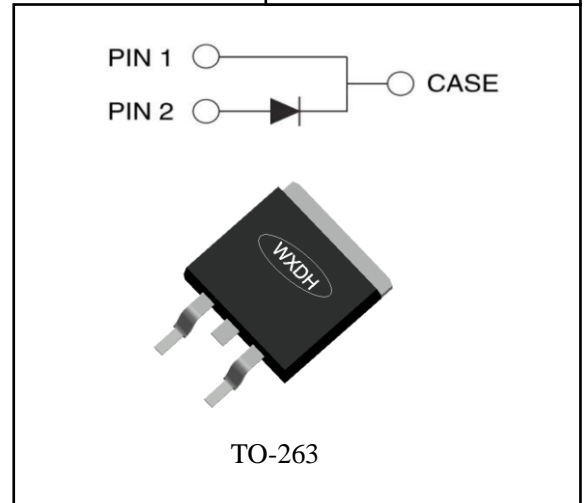
 $V_{BRM}=650V$ 
 $I_F (T_C \leq 135^\circ C) = 30A$ 
 $Q_C = 41nC$ 

## 4 Electrical Characteristics

### 4.1 Absolute Maximum Ratings (Tc=25°C, unless otherwise noted)

PARAMETER	SYMBOL	VALUE	UNIT
Peak Repetitive Reverse Voltage	$V_{RRM}$	650	V
Working Peak Reverse Voltage	$V_{RWM}$	650	V
DC Blocking Voltage	$V_R$	650	V
Forward Current	$I_F$	(Tc≤135°C)	30
		(Tc≤154°C)	20
Nonrepetitive Peak Surge Current(t=8.3ms)	$I_{FSM}$	160	A
Power dissipation	$P_{tot}$	214	W
Operating Junction Temperature Range	$T_j$	-55~175	°C
Storage Temperature Range	$T_{stg}$	-55~175	°C
Soldering Temperature	$T_{sold}$	260	°C

### 4.2 Thermal Characteristics

PARAMETER	SYMBOL	VALUE	UNIT
Thermal Resistance from Junction to Case	$R_{thJC}$	0.7	°C/W
Thermal Resistance from Junction to Ambient	$R_{thJA}$	80	°C/W

4.3 Electrical Characteristics (Tc=25°C, unless otherwise noted)

PARAMETER	SYMBOL	TEST CONDITION	MIN	TYP	MAX	UNIT
Maximum Instantaneous Forward Voltage	V <sub>F</sub>	I <sub>F</sub> = 20A	-	1.3	1.5	V
		I <sub>F</sub> = 20A, T <sub>J</sub> =175°C	-	1.4	1.7	V
Maximum Instantaneous Reverse	I <sub>R</sub>	V <sub>R</sub> = 650V	-	10	100	uA
		V <sub>R</sub> = 650V, T <sub>a</sub> =175°C	-	40	400	uA
Total capacitance	C <sub>tot</sub>	V <sub>R</sub> =0V, f=1MHz	-	1210	-	pF
		V <sub>R</sub> =200V, f=1MHz	-	124	-	
		V <sub>R</sub> =400V, f=1MHz	-	90	-	
Total capacitive Charge	Q <sub>C</sub>	V <sub>R</sub> =400V, I <sub>F</sub> =20A, di/dt=200A/us	-	41	-	nC

DEFINITIONS

V<sub>F</sub> = Instantaneous forward voltage (pw = 300µs, D = 2%).

I<sub>R</sub> = Instantaneous reverse current.

RθJC = Thermal resistance junction to case.

pw = pulse width.

D = duty cycle.

5 Typical characteristics diagrams

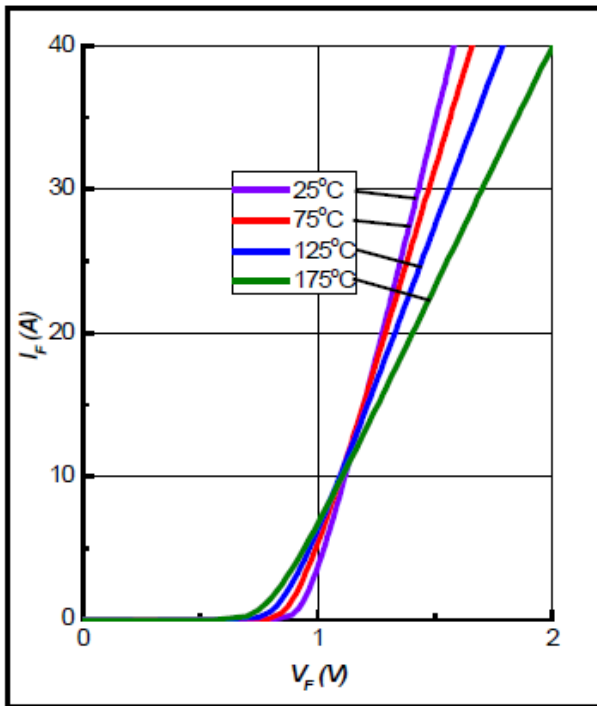

Figure 1. Forward Characteristics

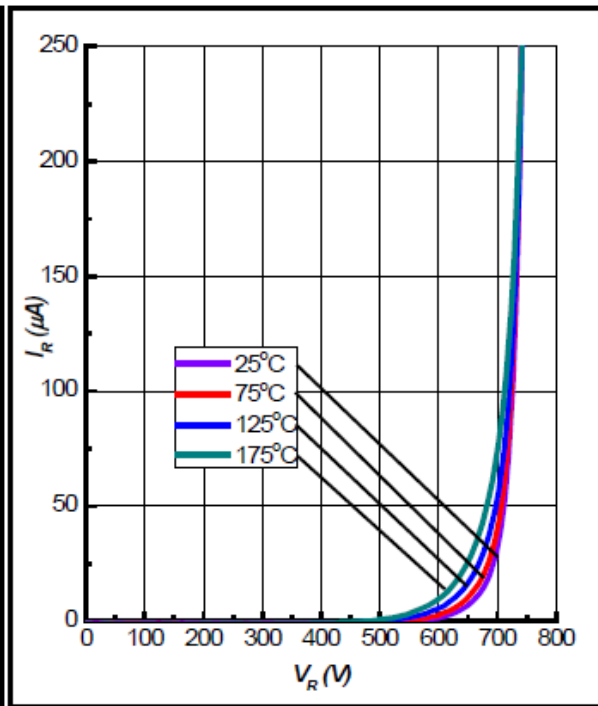

Figure 2. Reverse Characteristics

**5 Typical characteristics diagrams**

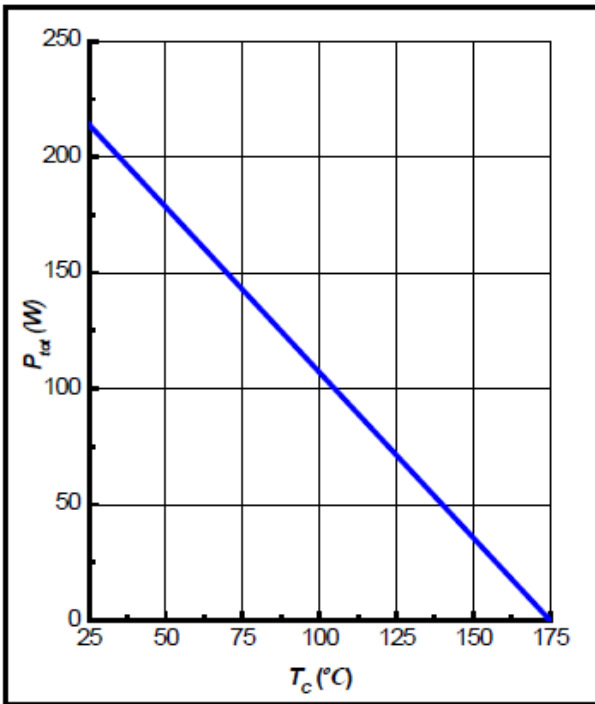

Figure 3. Power Derating

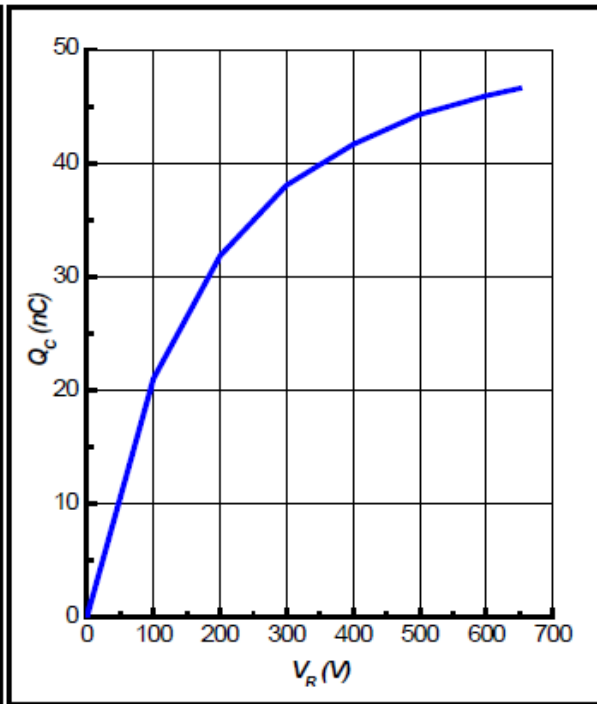

Figure 4. Total Capacitive Charge vs. Reverse Voltage

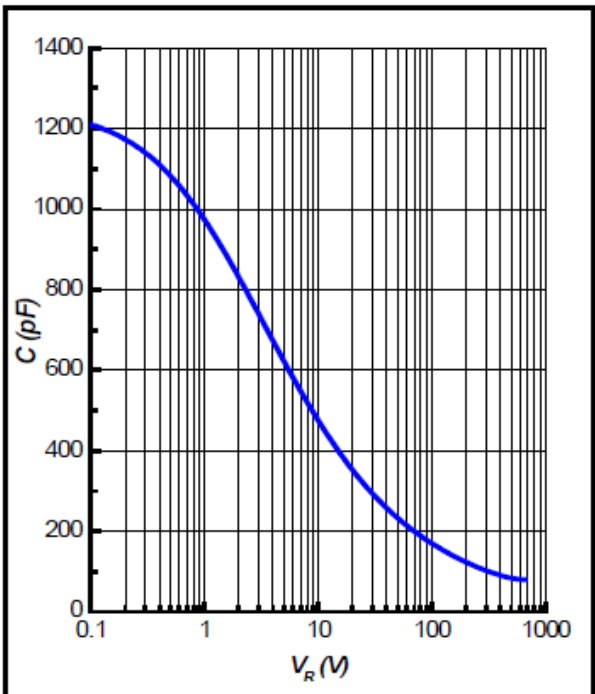

Figure 5. Total Capacitance vs. Reverse Voltage

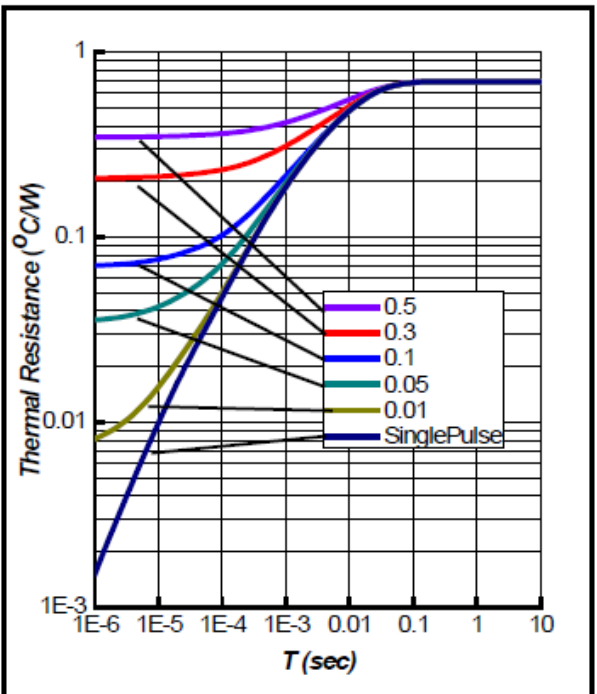

Figure 6. Transient Thermal Impedance

**6 Product Specifications and Packaging Models**

Product Model	Package Type	Mark Name
DCE20D65G4	TO-263	DCE20D65G4

## 7 Dimensions

### TO-263 PACK OUTLINE DIMENSIONS

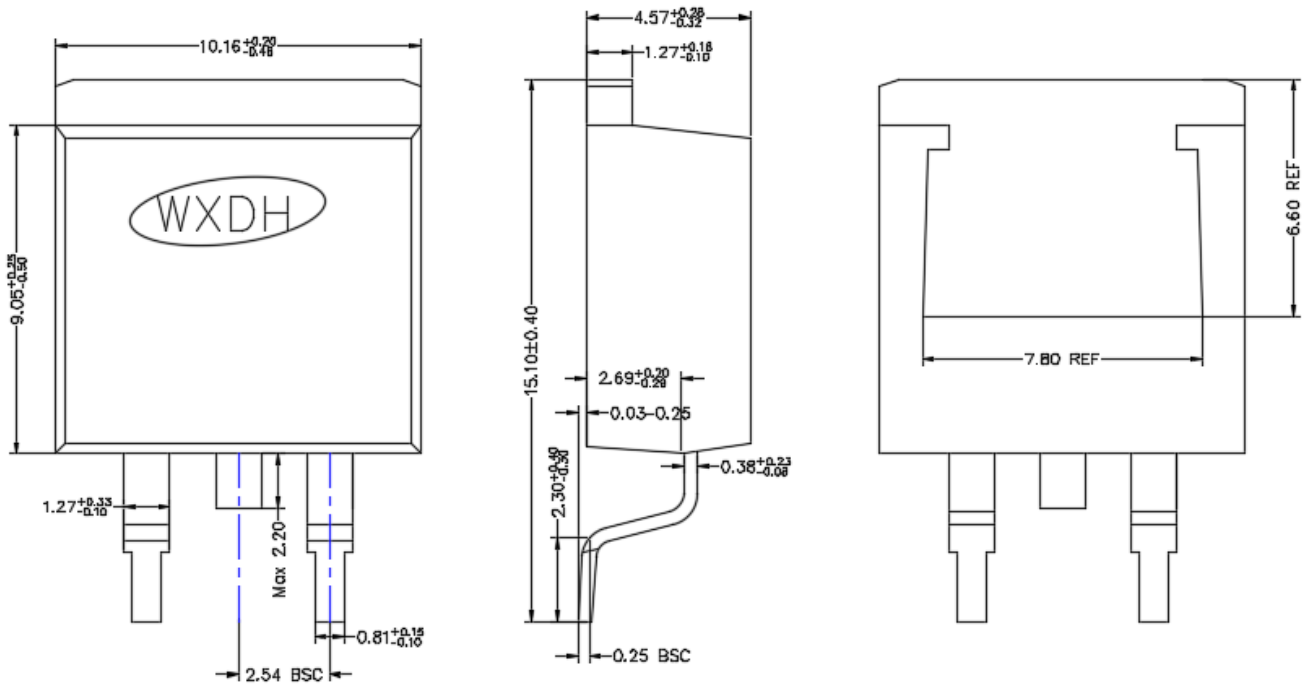

## 8 Attentions

- Jiangsu Donghai Semiconductor Co.,Ltd. reserves the right to change the specification without prior notice! The customer should obtain the latest version of the information before making the order and verify that the information is complete and up to date.
- It is the responsibility of the purchaser for any failure or failure of any semiconductor product under certain conditions. It is the responsibility of the purchaser to comply with safety standards and to take safety measures in the system design and machine manufacturing of Jiangsu Donghai Semiconductor Co.,Ltd. products in order to avoid potential risk of failure. Injury or property damage.
- Product promotion is endless, our company will be dedicated to provide customers with better products.

## 9 Appendix

Revision history:

Date	REV.	Description	Page
2022.03.25	1.0	Original	4