

50A 650V Trenchstop Insulated Gate Bipolar Transistor

1 Description

Using DongHai's proprietary Trench design and advance FS technology, the 650V FS IGBT offers superior and switching performances, high avalanche ruggedness easy parallel operation

2 Features

- FS Trench Technology, Positive temperature coefficient
- Low saturation voltage: $V_{CE(sat)}$, typ = 2.0V @ $I_C = 50A$ and $T_j = 25^\circ C$
- Extremely enhanced avalanche capability

3 Applications

- Welding
- UPS
- Three-level Inverter

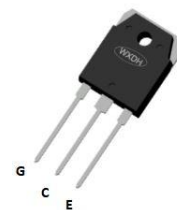
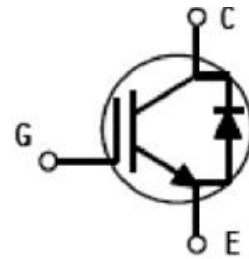

Type	V_{CE}	I_C	$V_{cesat}, T_j=25^\circ C$	T_{jmax}	Package
G50T65D	650V	50A	2.0V	175°C	TO-3PN

4 Electrical Characteristics

4.1 Absolute Maximum Ratings ($T_j=25^\circ C$, unless otherwise noted)

Parameter	Symbol	Value	Units
Collector-to-Emitter Voltage	V_{CE}	650	V
Gate-to-Emitter Voltage	V_{GE}	± 30	V
DC Collector current	I_C	$T_j=25^\circ C$	100
		$T_j=100^\circ C$	50
Pulsed Collector Current ⁽¹⁾	I_{CM}	200	A
Diode forward current	I_F	$T_j=25^\circ C$	40
		$T_j=100^\circ C$	20
Diode Pulsed Current	I_{FM}	80	A
Short circuit withstand time, $V_{GE}=15V$, $V_{CC}=400V$, $T_j=150^\circ C$	T_{SC}	6	μs
Power Dissipation	P_{tot}	$T_j=25^\circ C$	320
		$T_j=100^\circ C$	160
Junction Temperature Range	T_j	-45~175	$^\circ C$
Storage Temperature Range	T_{stg}	-45~150	$^\circ C$
Soldering temperature	T_L	260	$^\circ C$

4.2 Thermal Characteristics

Parameter	Symbol	Rating	Units
IGBT Thermal Resistance, Junction to Case-sink	R_{thJC}	0.47	$^{\circ}C/W$
IGBT Thermal Resistance, Junction to Ambient	R_{thJA}	39.2	$^{\circ}C/W$
Diode Thermal Resistance, Junction to Case-sink	R_{thJC}	1.2	$^{\circ}C/W$

4.3 Electrical Characteristics ($T_j=25^{\circ}C$, unless otherwise noted)

Parameter	Symbol	Test Condition	Value			Units
			Min	Typ	Max	
Off Characteristics						
Collector-to-Emitter Breakdown Voltage	V_{CE}	$I_C=1mA, V_{GE}=0V$	650	--	--	V
Collector-to-Emitter Leakage Current	I_{CES}	$V_{CE}=650V, V_{GE}=0V$	--	--	1	μA
Gate-to-Emitter Leakage Current	I_{GES}	$V_{GE}=\pm 30V, V_{CE}=0V$	--	--	± 100	nA
On Characteristics						
Gate Threshold Voltage	$V_{GE(th)}$	$V_{CE}=V_{GE}, I_C=1mA$	5	6	7	V
Collector-emitter saturation voltage	V_{CEsat}	$V_{GE}=15V, I_C=50A, T_j=25^{\circ}C$	--	2.0	2.5	V
		$V_{GE}=15V, I_C=50A, T_j=175^{\circ}C$	--	2.7	--	V
Transconductance	g_{fs}	$V_{CE}=20V, I_C=50A$	--	30	--	S
Dynamic Characteristics						
Input Capacitance	C_{iss}	$V_{CE}=25V, V_{GE}=0V, f=1MHz$	--	2528	--	pF
Output Capacitance	C_{oss}		--	115	--	
Reverse Transfer Capacitance	C_{rss}		--	24	--	
Switching Characteristics						
Turn-on delay time	$t_{d(on)}$	$V_{CE}=400V, I_C=50A,$ $R_g=5\Omega, V_{GE}=15V,$ 感性负载, $T_j=25^{\circ}C$	--	25	--	nS
Rise time	t_r		--	72	--	nS
Turn-off delay time	$t_{d(off)}$		--	60	--	nS
Fall time	t_f		--	86	--	nS
Turn-on energy	E_{on}		--	0.95	--	mJ
Turn-off energy	E_{off}		--	0.98	--	mJ
Total switching energy	E_{ts}		--	1.93	--	mJ
Turn-on delay time	$t_{d(on)}$	$V_{CE}=400V, I_C=50A,$ $R_g=5\Omega, V_{GE}=15V,$ 感性负载, $T_j=175^{\circ}C$	--	25	--	nS
Rise time	t_r		--	69	--	nS
Turn-off delay time	$t_{d(off)}$		--	78	--	nS
Fall time	t_f		--	155	--	nS
Turn-on energy	E_{on}		--	0.98	--	mJ
Turn-off energy	E_{off}		--	1.06	--	mJ
Total switching energy	E_{ts}		--	2.04	--	mJ
Gate charge	Q_g	$V_{CE}=520V, I_C=50A,$ $V_{GE}=15V$	--	86	--	nC

Parameter	Symbol	Test Condition	Value			Units
			Min	Typ	Max	
Diode Characteristic						
Diode forward voltage	V_F	$I_F=20A, T_j=25^\circ C$	--	1.7	2.2	V
		$I_F=20A, T_j=175^\circ C$	--	1.3	--	V
Diode reverse recovery time	t_{rr}	$I_F=20A, di/dt=100A/uS$	--	124	--	nS
Diode peak reverse recovery current	I_{RRM}		--	1.4	--	A
Diode reverse recovery charge	Q_{rr}		--	98	--	nC

Notes:

1.Pulse duration is limited by $T_{j,max}$

5 Typical Characteristic Curves

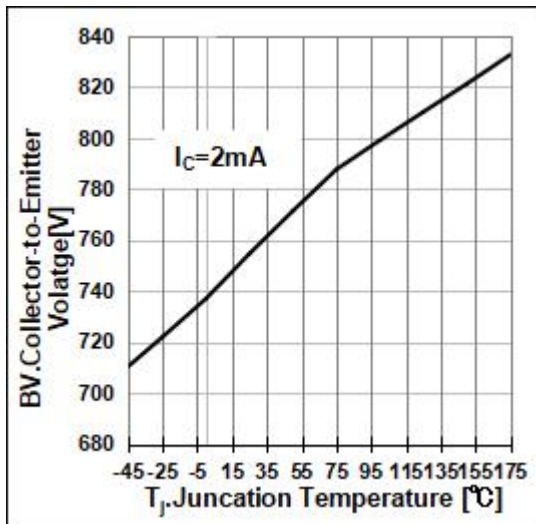

Fig1. Collector-to-Emitter Breakdown Voltage Temperature characteristic

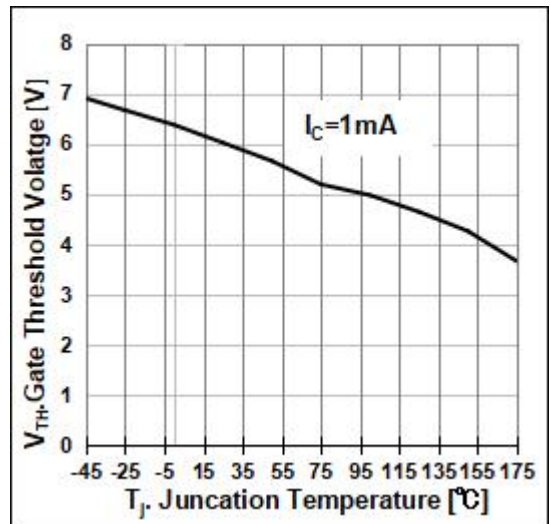

Fig2. Gate Threshold Voltage Temperature characteristic

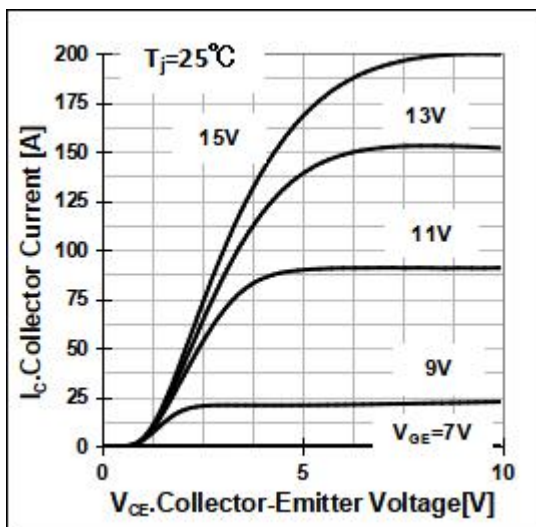

Fig3. Typical output characteristic

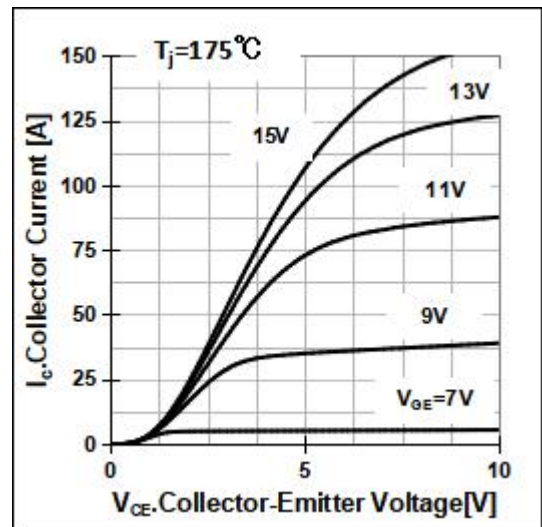

Fig4. Typical output characteristic

5 Typical Characteristic Curves(Continue)

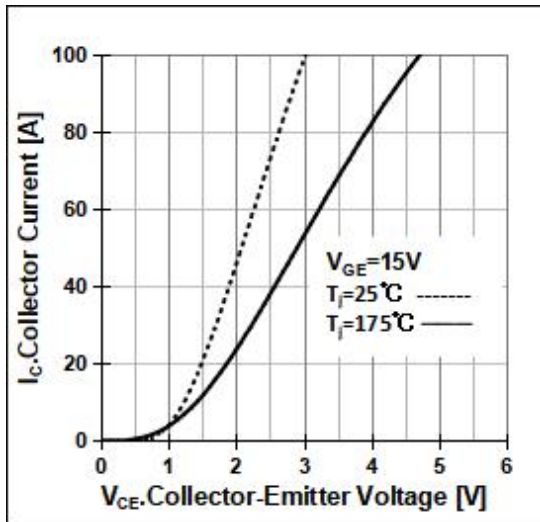

Fig5. Collector-emitter saturation voltage Characteristic

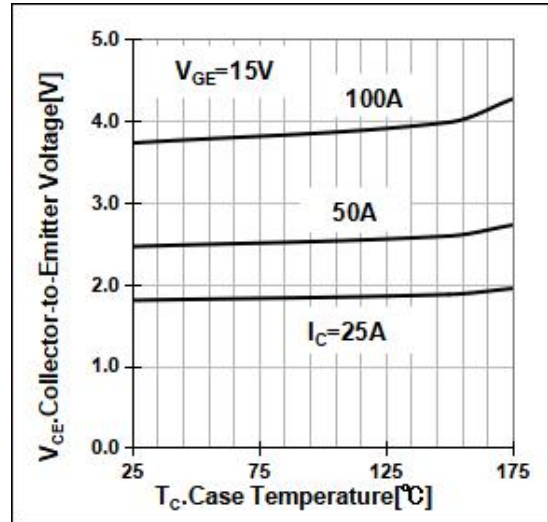

Fig6. Collector-emitter saturation voltage Temperature Characteristic

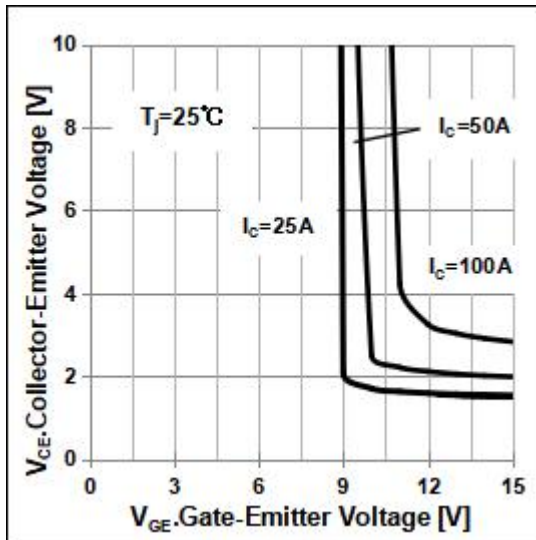

Fig7. Typical Transfer characteristic curve of Saturation Voltage vs Vge

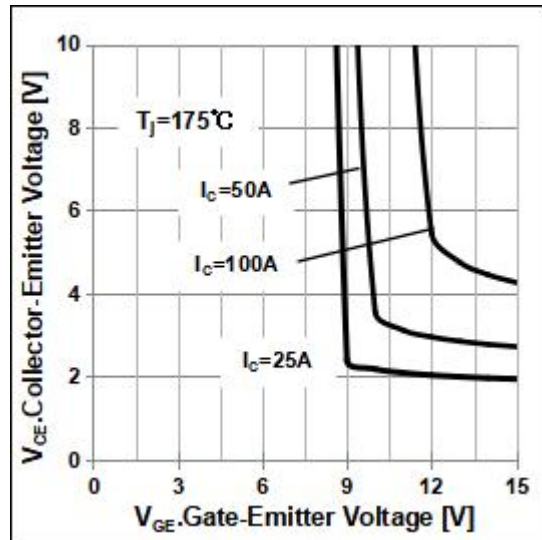

Fig8. Typical Transfer characteristic curve of Saturation Voltage vs Vge

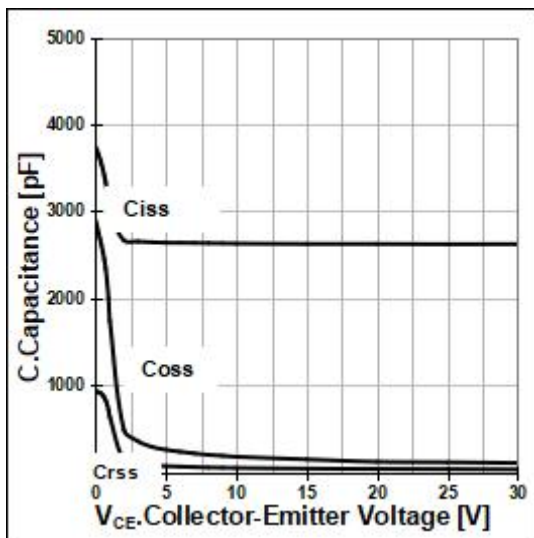

Fig9. Typical capacitance as a function of collector-emitter voltage

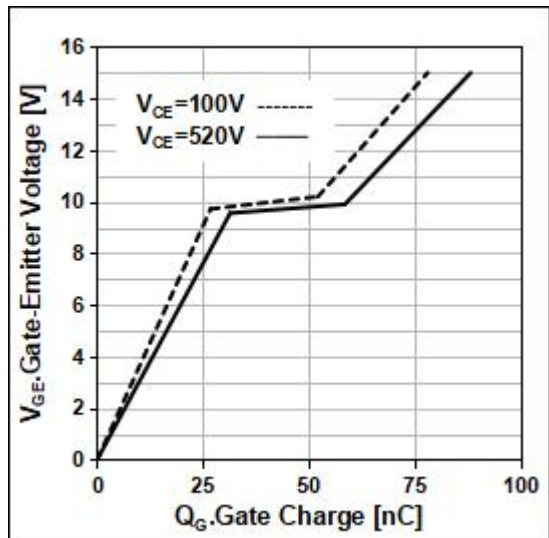

Fig10. Typical gate charge

5 Typical Characteristic Curves(Continue)

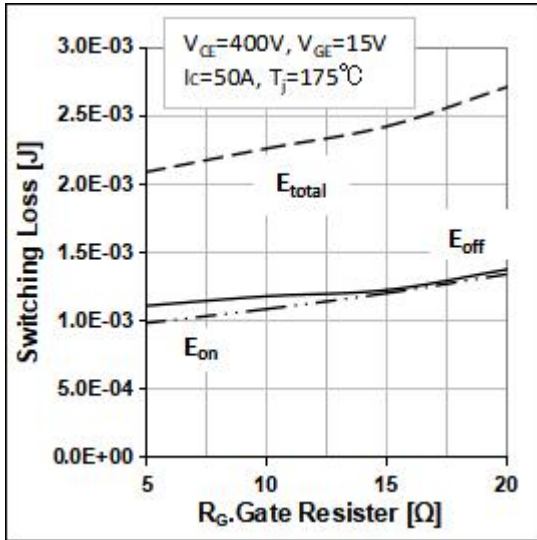

Fig11. Typical switching energy losses as a function of gate resistor

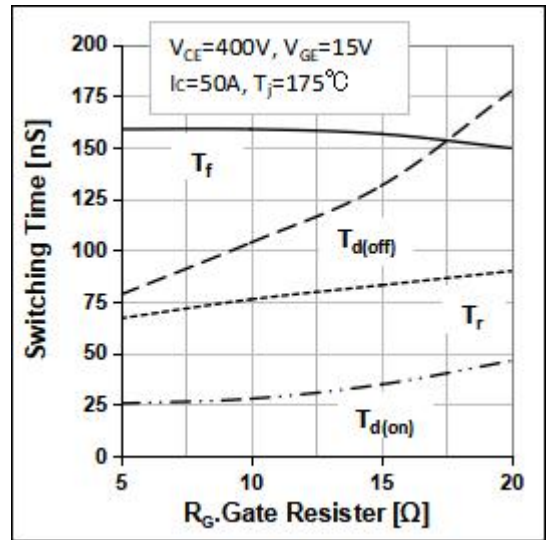

Fig12. Typical switching times as a function of gate resistor

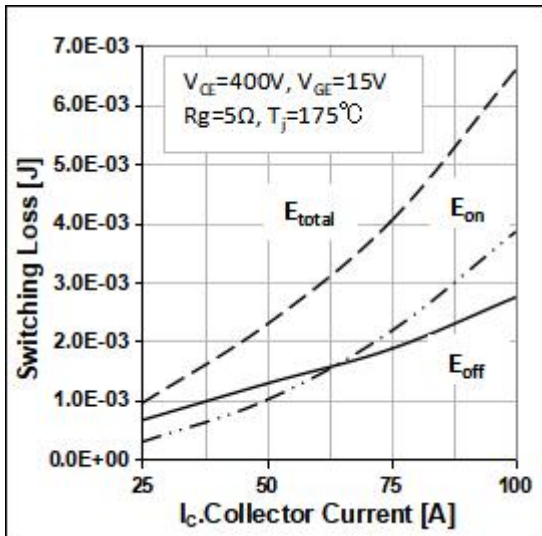

Fig13. Typical switching energy losses as a function of Collector Current

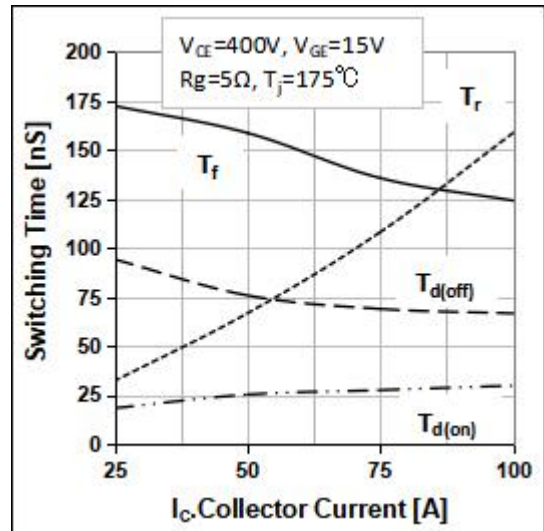

Fig14. Typical switching times as a function of Collector Current

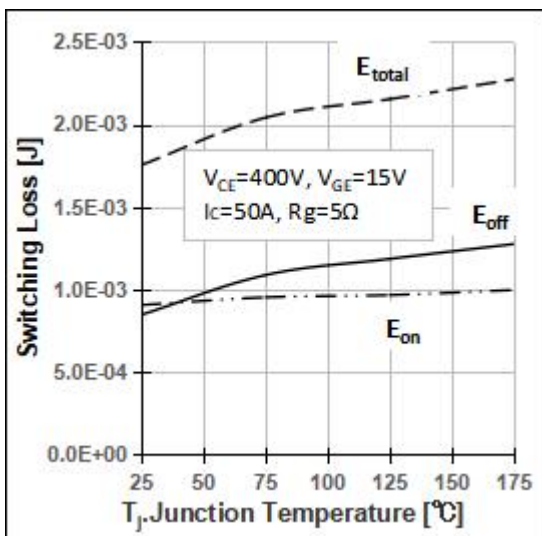

Fig15. Typical switching energy losses as a function of Junction temperature

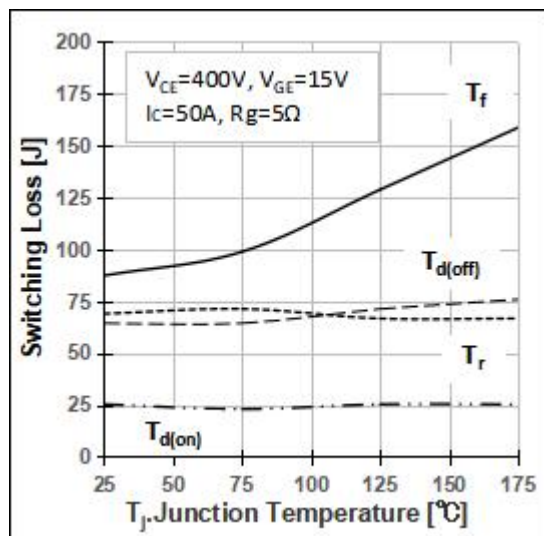

Fig16. Typical switching times as a function of Junction temperature

5 Typical Characteristic Curves(Continue)

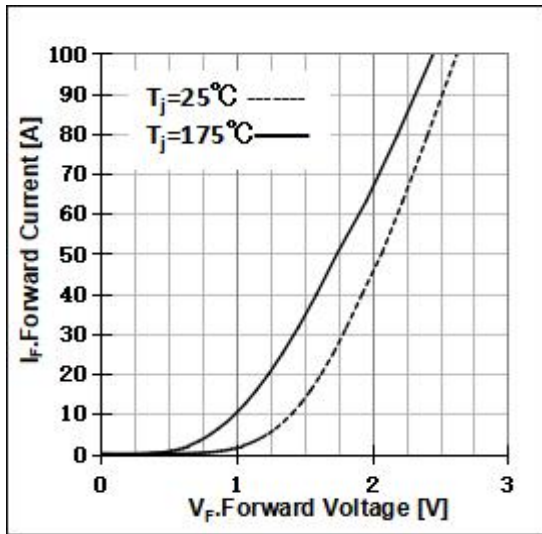

Fig17. Typical diode forward current as a function of forward voltage

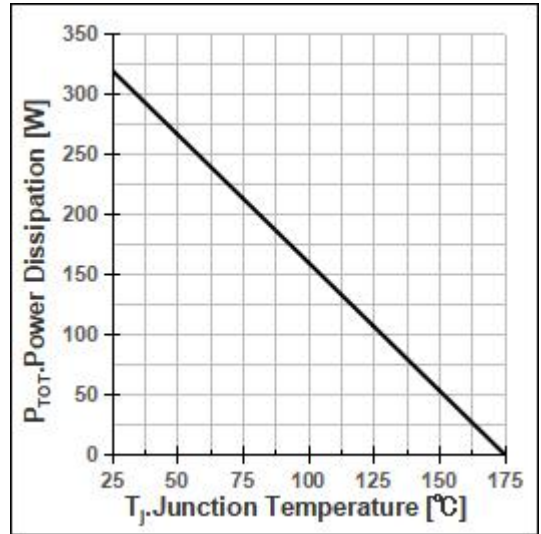

Fig18. Power dissipation temperature characteristic

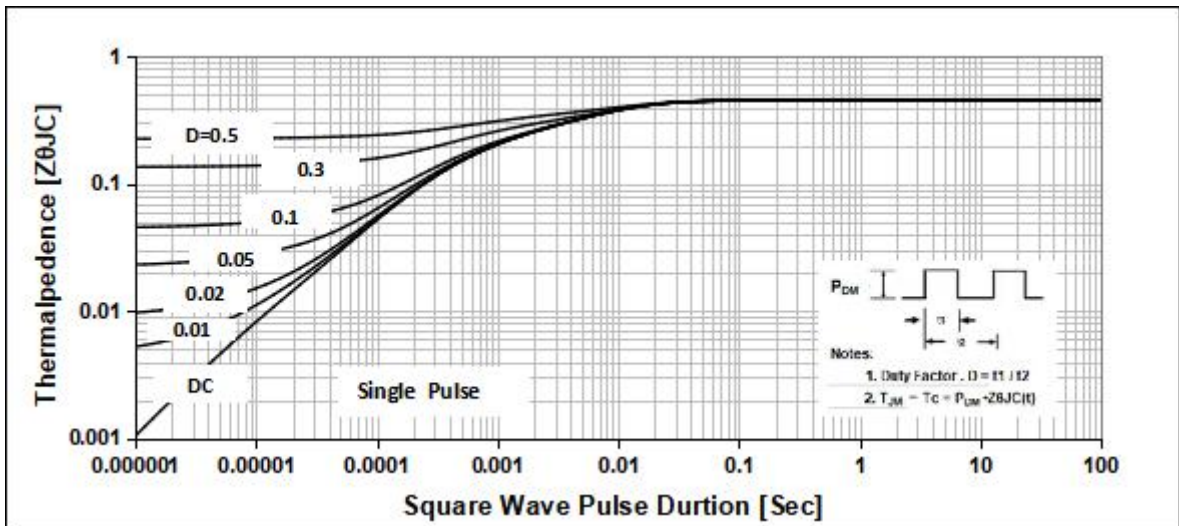
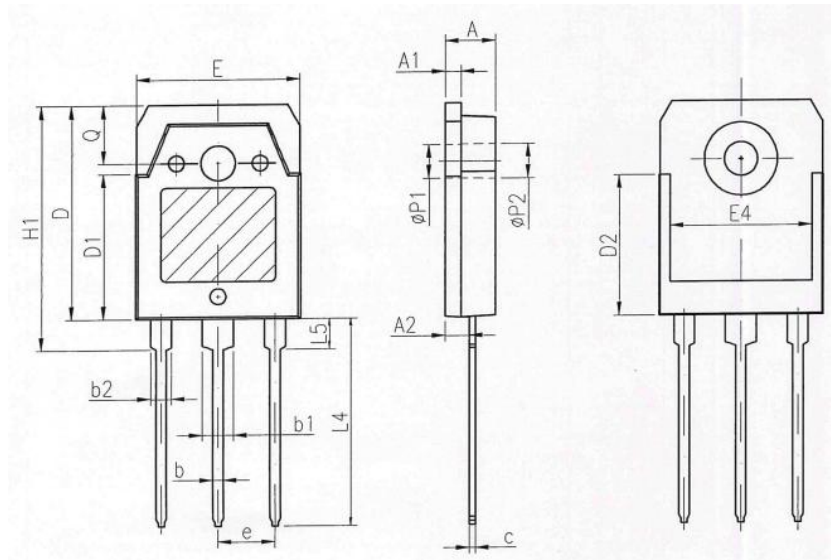

Fig19. IGBT transient thermal resistance

6 Dimensions (TO-3PN)



项 目	规范(mm)		项 目	规范(mm)	
	MIN	MAX		MIN	MAX
A	4.6	5	E	15.4	15.8
A1	1.45	1.65	E4	12.6	--
A2	2.2	2.6	e	5.15	5.75
b	0.8	1.2	H1	22.65	23.15
b1	2.8	3.2	L4	19.8	20.2
b2	1.8	2.2	L5	3.3	3.7
c	0.55	0.75	ΦP1	3.20 REF	
D	19.2	19.7	ΦP2	3.50 REF	
D1	13.1	14.7	Q	5.00 REF	
D2	12.40 REF				

7 Attentions

- Jiangsu Donghai Semiconductor CO.,LTD. reserves the right to change the specification without prior notice! The customer should obtain the latest version of the information before making the order and verify that the information is complete and up to date.
- It is the responsibility of the purchaser for any failure or failure of any semiconductor product under certain conditions. It is the responsibility of the purchaser to comply with safety standards and to take safety measures in the system design and machine manufacturing of Donghai products in order to avoid potential risk of failure. Injury or property damage.
- Product promotion is endless, our company will be dedicated to provide customers with better products.

8 Appendix

Revision history:

Date	REV.	Description	Page
2022.11.02	1.0	Original	